

LMV761/LMV762

Low Voltage, Precision Comparator with Push-Pull Output

General Description

The LMV761/LMV762 are precision comparators intended for applications requiring low noise and low input offset voltage. The LV761 single has a shutdown pin that can be used to disable the device and reduce the supply current. The LMV761 is available in a space saving 6-Pin SOT-23 or 8-Pin SOIC package. The LMV762 dual is available in 8-Pin SOIC or MSOP package.

They feature a CMOS input and Push-Pull output stage. The Push-Pull output stage eliminates the need for an external pull-up resistor.

The LMV761/LMV762 are designed to meet the demands of small size, low power and high performance required by portable and battery operated electronics.

The input offset voltage has a typical value of 200 μ V at room temp and a 1mV limit over temp.

Features

($V_S = 5V$, $T_A = 25^\circ C$, typical values unless specified).

- Input offset voltage 0.2mV
- Input offset voltage (max over temp) 1mV
- Input bias current 0.2pA
- Propagation delay (OD = 50mV) 120 nsec
- Low supply current 300 μ A
- CMRR 100dB
- PSRR 110dB
- Extended Temperature Range $-40^\circ C$ to $125^\circ C$
- Push-pull output
- Ideal for 2.7V and 5V single supply applications
- Available in space-saving packages:
 - 6-Pin SOT-23 (single w/shutdown)
 - 8-Pin SOIC (single w/shutdown)
 - 8-Pin SOIC/MSOP (dual without shutdown)

Applications

- Portable and battery-powered systems
- Scanners
- Set top boxes
- High speed differential line receiver
- Window comparators
- Zero-crossing detectors
- High speed sampling circuits

Typical Circuit

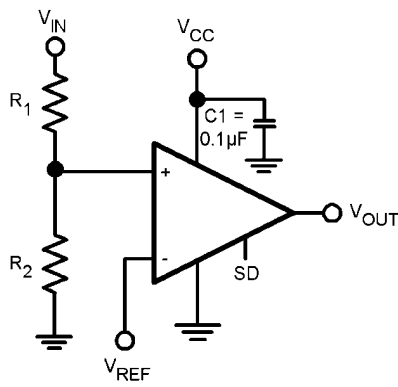

Threshold Detector

20037032

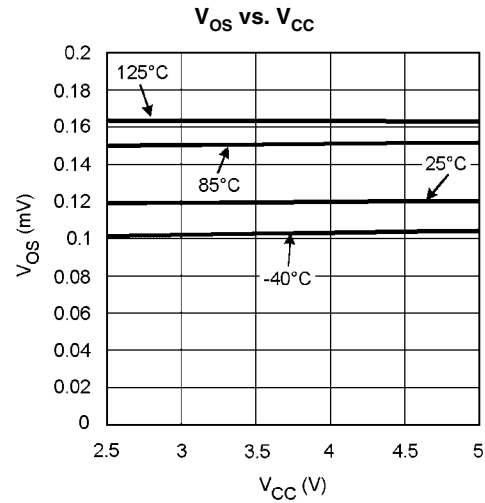

20037010

Absolute Maximum Ratings (Note 1)

If Military/Aerospace specified devices are required, please contact the National Semiconductor Sales Office/Distributors for availability and specifications.

ESD Tolerance (Note 2)	
Human Body Model	2000V
Machine Model	200V
Supply Voltage (V+ – V-)	5.5V
Differential Input Voltage	Supply Voltage
Voltage between any two pins	Supply Voltage
Output Short Circuit Duration (Note 9)	
Current at Input Pin	±5 mA

Soldering Information

Infrared or Convection (20 sec.)	235°C
Wave Soldering (10 sec.)	260°C (Lead Temp)
Junction Temperature	150°C
Storage Temperature Range	-65°C to 150°C

Operating Ratings

Supply Voltage (V+ – V-)	2.7V to 5.0V
Temperature Range	-40°C to +125°C
Package Thermal Resistance (Note 4)	
6-Pin SOT-23	265°C/W
8-Pin SOIC	190°C/W
8-Pin MSOP	235°C/W

2.7V Electrical Characteristics

Unless otherwise specified, all limited guaranteed for $T_J = 25^\circ\text{C}$, $V_{CM} = V^+/2$, $V^+ = 2.7\text{V}$, $V^- = 0\text{V}$. **Boldface** limits apply at the temperature extremes. (Note 5)

Symbol	Parameter	Condition	Min (Note 7)	Typ (Note 6)	Max (Note 7)	Units
V_{OS}	Input Offset Voltage			0.2	1.0	mV
I_B	Input Bias Current (Note 8)			0.2	50	pA
I_{OS}	Input Offset Current (Note 8)			.001	5	pA
CMRR	Common Mode Rejection Ratio	$0\text{V} < V_{CM} < V_{CC} - 1.3\text{V}$	80	100		dB
PSRR	Power Supply Rejection Ratio	$V^+ = 2.7\text{V to } 5\text{V}$	80	110		dB
CMVR	Input Common Mode Voltage Range	CMRR > 50dB			-0.3 1.5	V
V_O	Output Swing High	$I_L = 2\text{mA}$, $V_{ID} = 200\text{mV}$	$V^+ - 0.35$	$V^+ - 0.1$		V
	Output Swing Low	$I_L = -2\text{mA}$, $V_{ID} = -200\text{mV}$		90	250	mV
I_{SC}	Output Short Circuit Current (Note 3)	Sourcing, $V_O = 1.35\text{V}$, $V_{ID} = 200\text{mV}$	6.0	20		mA
		Sinking, $V_O = 1.35\text{V}$, $V_{ID} = -200\text{mV}$	6.0	15		
I_S	Supply Current					μA
	LMV761 (Single Comparator)			275	700	
	LMV762 (Both Comparators)			550	1400	
$I_{OUT\ LEAKAGE}$	Output Leakage I @ Shutdown	$\overline{SD} = \text{GND}$, $V_O = 2.7\text{V}$		0.20		μA
$I_{S\ LEAKAGE}$	Supply Leakage I @ Shutdown	$\overline{SD} = \text{GND}$, $V_{CC} = 2.7\text{V}$		0.20	2	μA
t_{PD}	Propagation Delay $R_L = 5.1\text{k}\Omega$ $C_L = 50\text{pF}$	Overdrive = 5mV		270		ns
		Overdrive = 10mV		205		
		Overdrive = 50mV		120		
t_{SKEW}	Propagation Delay Skew			5		ns
t_r	Output Rise Time	10% to 90%		1.7		ns
t_f	Output Fall Time	90% to 10%		1.8		ns
t_{on}	Turn On Time From Shutdown			6		μs

5.0V Electrical Characteristics

Unless otherwise specified, all limited guaranteed for $T_J = 25^\circ\text{C}$, $V_{CM} = V^+/2$, $V^+ = 5.0\text{V}$, $V^- = 0\text{V}$. **Boldface** limits apply at the temperature extremes.

Symbol	Parameter	Condition	Min (Note 7)	Typ (Note 6)	Max (Note 7)	Units
V_{OS}	Input Offset Voltage			0.2	1.0	mV
I_B	Input Bias Current (Note 8)			0.2	50	pA
I_{OS}	Input Offset Current (Note 8)			0.01	5	pA
CMRR	Common Mode Rejection Ratio	$0\text{V} < V_{CM} < V_{CC} - 1.3\text{V}$	80	100		dB
PSRR	Power Supply Rejection Ratio	$V^+ = 2.7\text{V to } 5\text{V}$	80	110		dB
CMVR	Input Common Mode Voltage Range	CMRR > 50dB			-.3 3.8	V
V_O	Output Swing High	$I_L = 4\text{mA}$, $V_{ID} = 200\text{mV}$	$V^+ - 0.35$	$V^+ - 0.1$		V
	Output Swing Low	$I_L = -4\text{mA}$, $V_{ID} = -200\text{mV}$		120	250	mV
I_{SC}	Output Short Circuit Current (Note 3)	Sourcing, $V_O = 2.5\text{V}$, $V_{ID} = 200\text{mV}$	6.0	60		mA
		Sinking, $V_O = 2.5\text{V}$, $V_{ID} = -200\text{mV}$	6.0	40		
I_S	Supply Current					μA
	LMV761 (Single Comparator)			225	700	
	LMV762 (Both Comparators)			450	1400	
$I_{OUT\ LEAKAGE}$	Output Leakage I @ Shutdown	$\overline{SD} = \text{GND}$, $V_O = 5.0\text{V}$		0.20		μA
$I_{S\ LEAKAGE}$	Supply Leakage I @ Shutdown	$\overline{SD} = \text{GND}$, $V_{CC} = 5.0\text{V}$		0.20	2	μA
t_{PD}	Propagation Delay $R_L = 5.1\text{k}\Omega$ $C_L = 50\text{pF}$	Overdrive = 5mV		225		ns
		Overdrive = 10mV		190		
		Overdrive = 50mV		120		
t_{SKEW}	Propagation Delay Skew			5		ns
t_r	Output Rise Time	10% to 90%		1.7		ns
t_f	Output Fall Time	90% to 10%		1.5		ns
t_{on}	Turn On Time from Shutdown			4		μs

Note 1: Absolute Maximum Ratings indicate limits beyond which damage to the device may occur. Operating Ratings indicate conditions for which the device is intended to be functional, but specific performance is not guaranteed. For guaranteed specifications and the test condition, see the Electrical Characteristics.

Note 2: Unless otherwise specified human body model is 1.5k Ω in series with 100pF. Machine model 200pF.

Note 3: Electrical Table values apply only for factory testing conditions at the temperature indicated. Factory testing conditions result in very limited self-heating of the device such that $T_J = T_A$. No guarantee of parametric performance is indicated in the electrical tables under conditions of internal self-heating where $T_J > T_A$. See Application section for information on temperature de-rating of this device. Absolute Maximum Rating indicate junction temperature limits beyond which the device may be permanently degraded, either mechanically or electrically.

Note 4: The maximum power dissipation is a function of $T_{J(MAX)}$, θ_{JA} , and T_A . The maximum allowable power dissipation at any ambient temperature is $P_D = (T_{J(MAX)} - T_A)\theta_{JA}$. All numbers apply for packages soldered directly into a PC board.

Note 5: Maximum temperature guarantee range is -40°C to 125°C .

Note 6: Typical values represent the most likely parametric norm.

Note 7: All limits are guaranteed by testing or statistical analysis.

Note 8: Guaranteed by design

Note 9: Applies to both single supply and split supply operation. Continuous short circuit operation at elevated ambient temperature can result in exceeding the maximum allowed junction temperature of 150°C . Output current in excess of $\pm 25\text{mA}$ over long term may adversely affect reliability.

Connection Diagrams

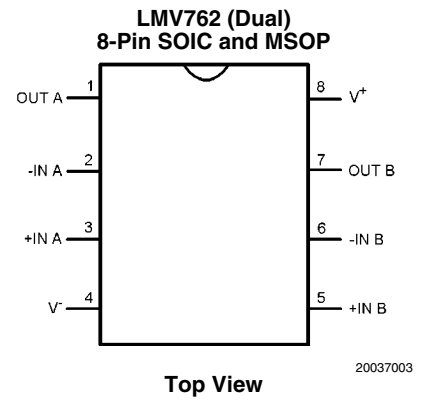
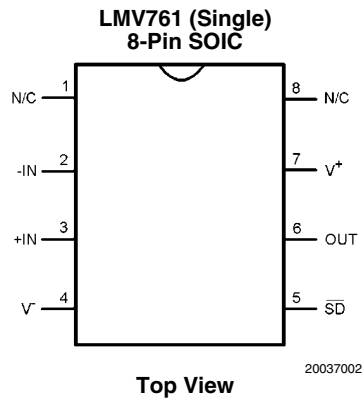
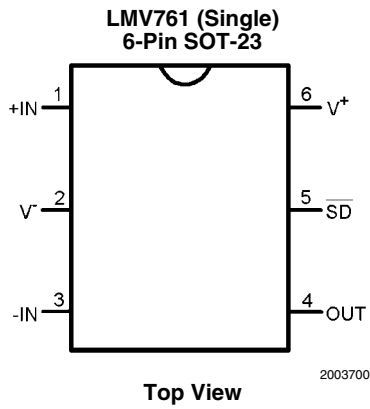

Ordering Information

Package	Part Number	Package Marking	Transport Media	NSC Drawing
6-Pin SOT-23	LMV761MF	C22A	1k units Tape and Reel	MF06A
	LMV761MFX		3k units Tape and Reel	
8-Pin SOIC	LMV761MA	LMV761MA	95 Units/Rail	M08A
	LMV761MAX		2.5k Units Tape and Reel	
	LMV762MA	LMV762MA	95 Units/Rail	
	LMV762MAX		2.5k Units Tape and Reel	
8-Pin MSOP	LMV762MM	C23A	1k Units Tape and Reel	MUA08A
	LMV762MMX		3.5k Units Tape and Reel	

Typical Performance Characteristics

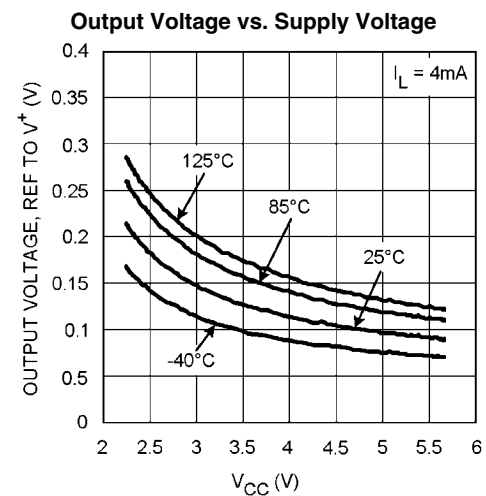
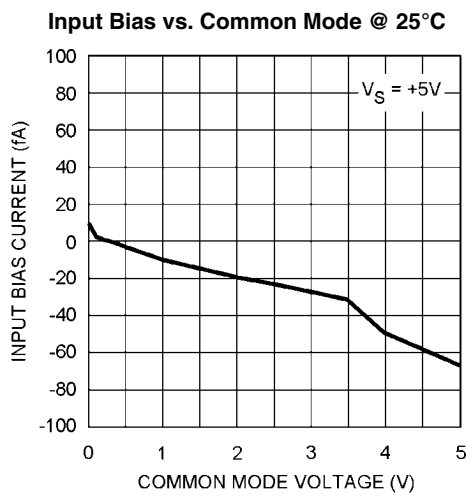
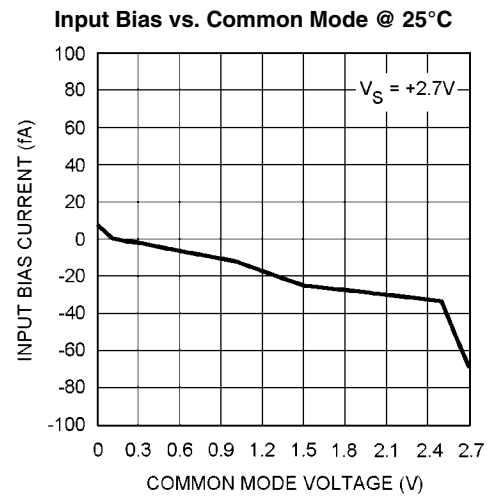
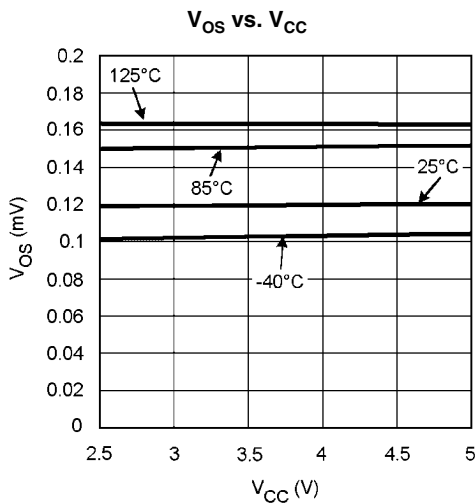
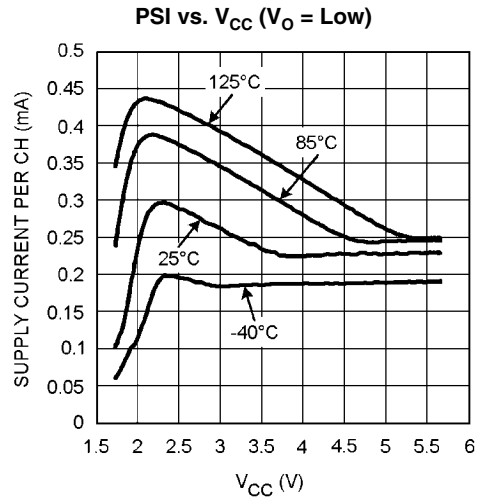
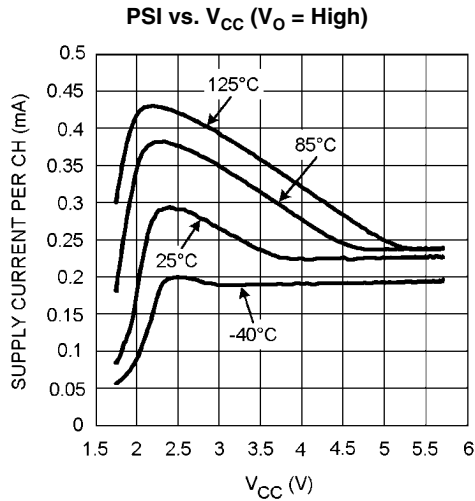

Output Voltage vs. Supply Voltage

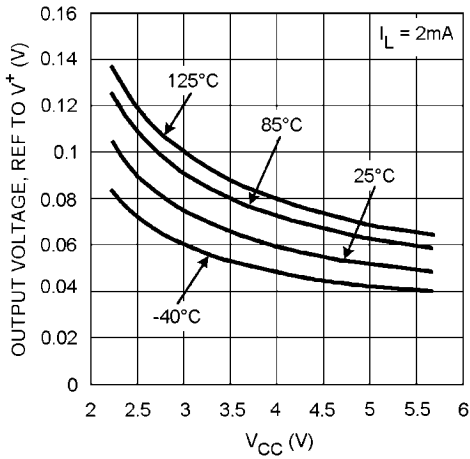

20037012

Output Voltage vs. Supply Voltage

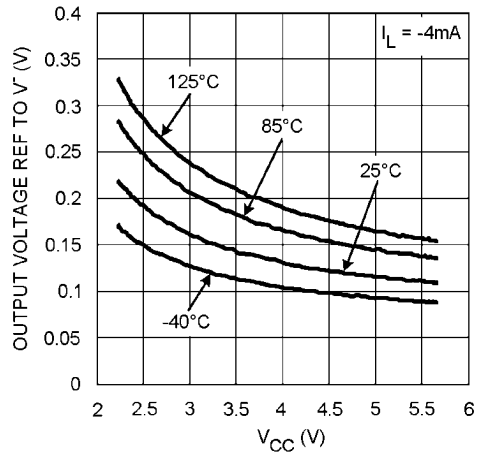

20037013

Output Voltage vs. Supply Voltage

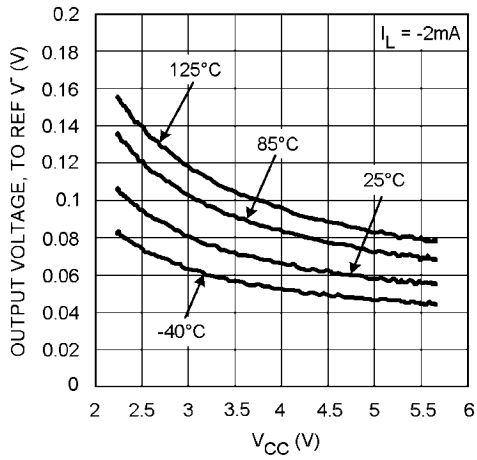

20037014

ISOURCE vs. VOUT

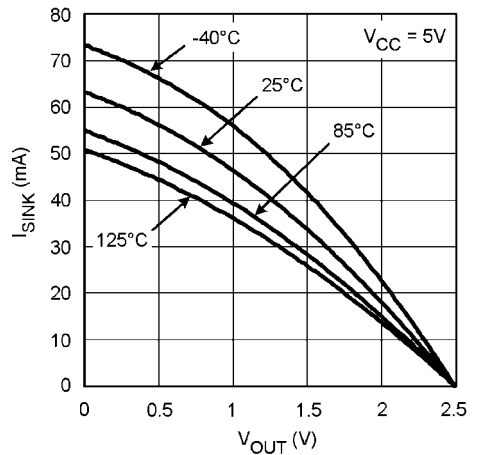

20037006

ISINK vs. VOUT

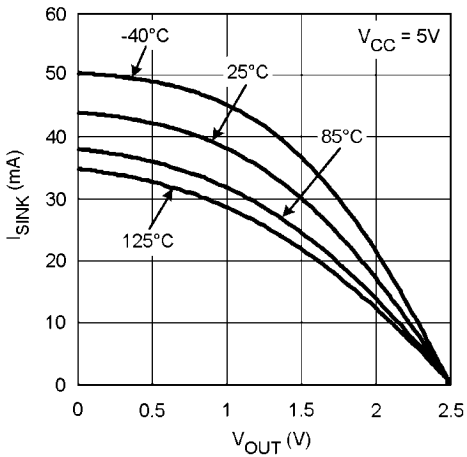

20037007

ISOURCE vs. VOUT

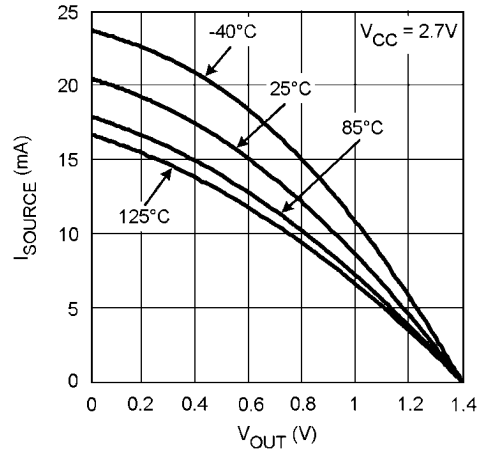

20037008

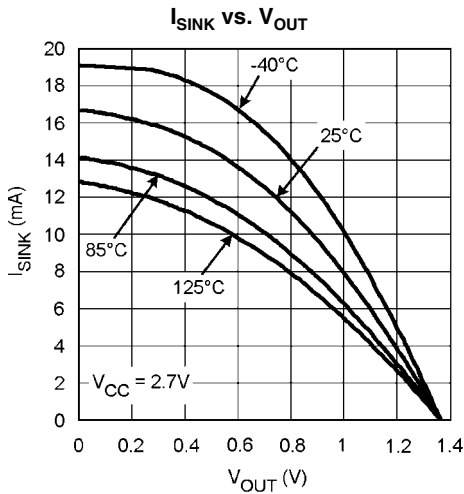

20037009

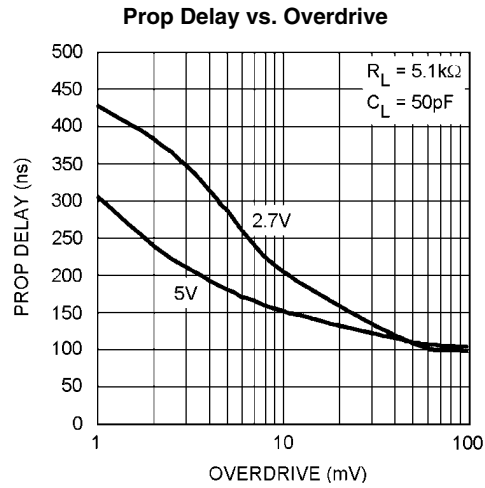

20037019

Response Time vs. Input Overdrives Positive Transition

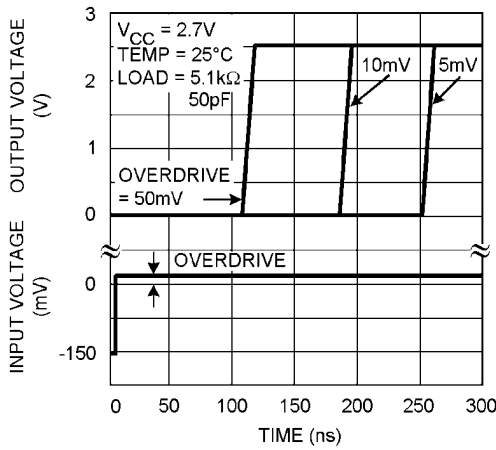

20037020

Response Time vs. Input Overdrives Positive Transition

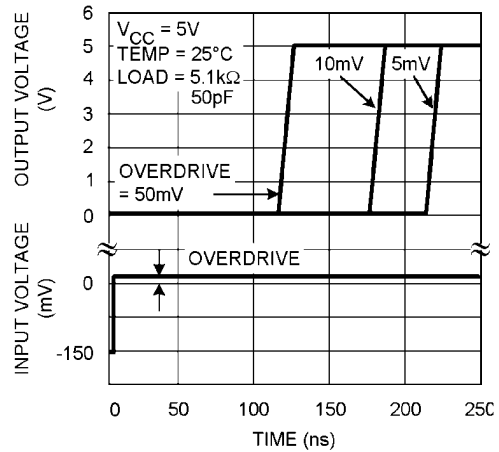

20037021

Response Time vs. Input Overdrives Negative Transition

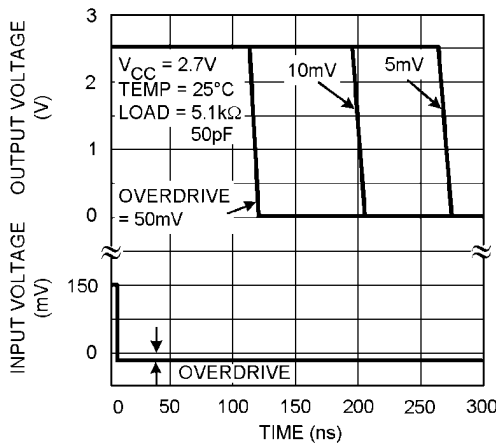

20037022

Response Time vs. Input Overdrives Negative Transition

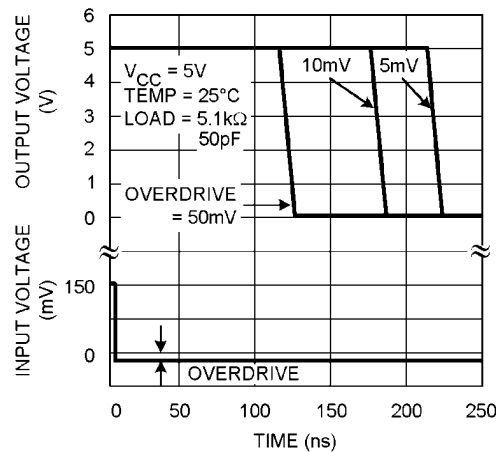

20037023

Application Information

BASIC COMPARATOR

A basic comparator circuit is used to convert analog input signals to digital output signals. The comparator compares an input voltage (V_{IN}) at the non-inverting input to the reference voltage (V_{REF}) at the inverting pin. If V_{IN} is less than V_{REF} the output (V_O) is low (V_{OL}). However, if V_{IN} is greater than V_{REF} , the output voltage (V_O) is high (V_{OH}).

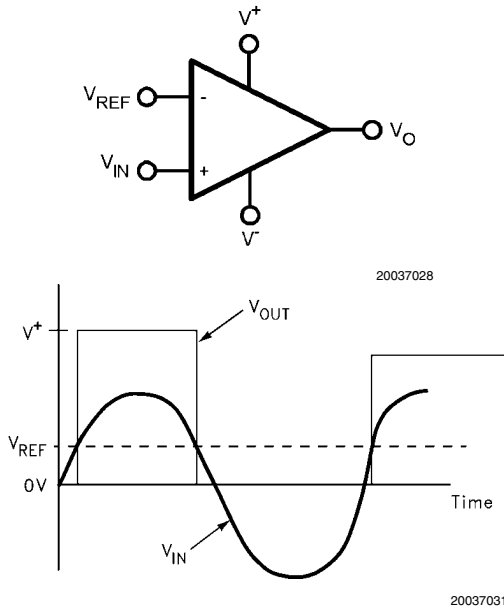

FIGURE 1. Basic Comparator

HYSTERESIS

The basic comparator configuration may oscillate or produce a noisy output if the applied differential input is near the comparator's input offset voltage. This tends to occur when the voltage on one input is equal or very close to the other input voltage. Adding hysteresis can prevent this problem. Hysteresis creates two switching thresholds (one for the rising input voltage and the other for the falling input voltage). Hysteresis is the voltage difference between the two switching thresholds. When both inputs are nearly equal, hysteresis causes one input to effectively move quickly past the other. Thus, moving the input out of the region in which oscillation may occur.

Hysteresis can easily be added to a comparator in a non-inverting configuration with two resistors and positive feedback *Figure 2*. The output will switch from low to high when V_{IN} rises up to V_{IN1} , where V_{IN1} is calculated by

$$V_{IN1} = (V_{REF}(R_1+R_2))/R_2$$

The output will switch from high to low when V_{IN} falls to V_{IN2} , where V_{IN2} is calculated by

$$V_{IN2} = (V_{REF}(R_1+R_2) - V_{CC} R_1)/R_2$$

The Hysteresis is the difference between V_{IN1} and V_{IN2} .

$$\begin{aligned} \Delta V_{IN} &= V_{IN1} - V_{IN2} \\ &= ((V_{REF}(R_1+R_2))/R_2) - ((V_{REF}(R_1+R_2) - (V_{CC} R_1))/R_2) \\ &= V_{CC} R_1/R_2 \end{aligned}$$

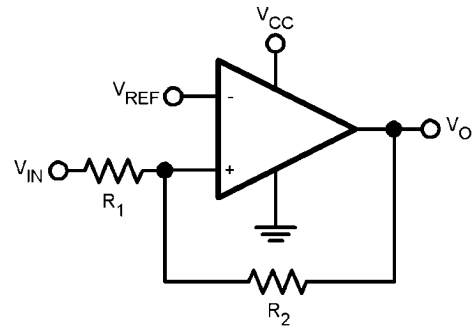

20037026

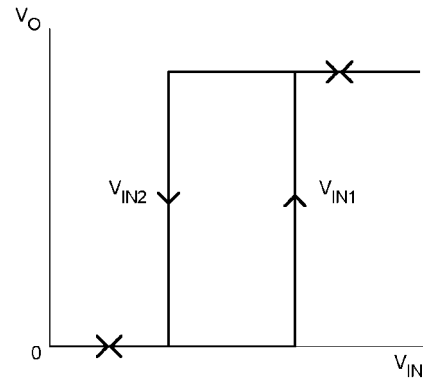

20037027

FIGURE 2. Non-Inverting Comparator Configuration

INPUT

The LMV761/LMV762 have near zero input bias current. This allows very high resistance circuits to be used without any concern for matching input resistances. This also allows the use of very small capacitors in R-C type timing circuits. This reduces the cost of the capacitors and amount of board space used.

SHUTDOWN MODE

The LMV761 features a low-power shutdown pin that is activated by driving \overline{SD} low. In shutdown mode, the output is in a high impedance state, supply current is reduced to 20nA and the comparator is disabled. Driving \overline{SD} high will turn the comparator on. The \overline{SD} pin should not be left unconnected due to the fact that it is a high impedance input. When left unconnected, the output will be at an unknown voltage. Also do not three-state the \overline{SD} pin.

The maximum input voltage for \overline{SD} is 5.5V, referred to ground and is not limited by V_{CC} . This allows the use of 5V logic to drive \overline{SD} while V_{CC} operates at a lower voltage, such as 3V. The logic threshold limits for \overline{SD} are proportional to V_{CC} .

BOARD LAYOUT AND BYPASSING

The LMV761/LMV762 is designed to be stable and oscillation free, but it is still important to include the proper bypass capacitors and ground pickups. Ceramic 0.1µF capacitors should be placed at both supplies to provide clean switching. Minimize the length of signal traces to reduce stray capacitance.

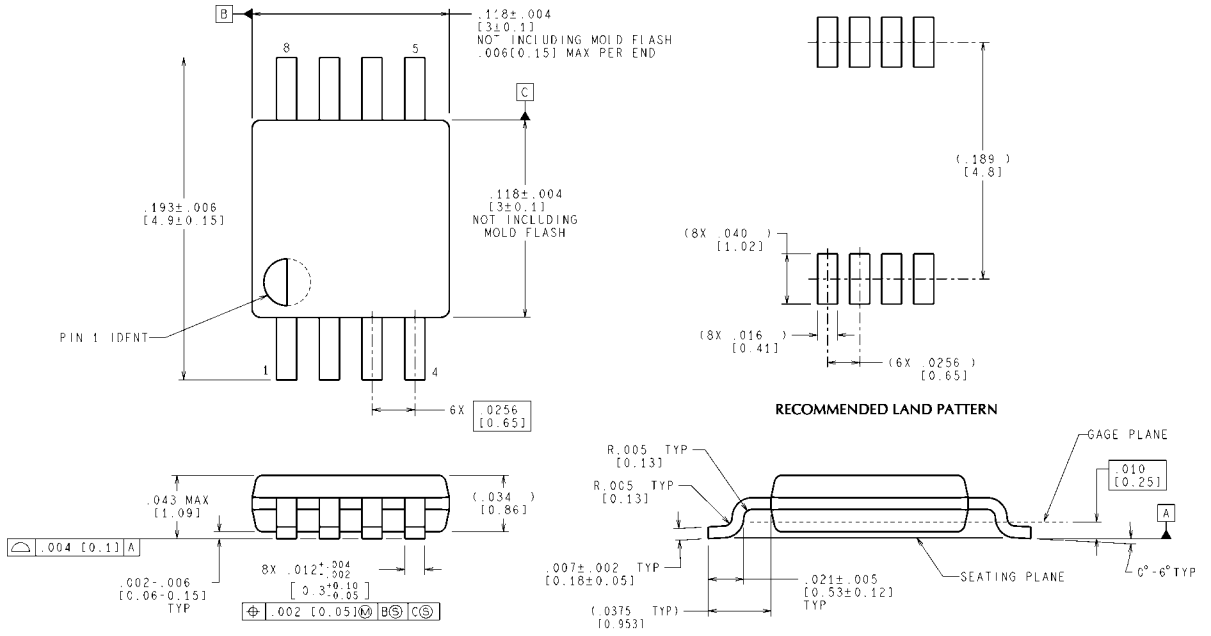

CONTROLLING DIMENSION IS INCH
 VALUES IN [] ARE MILLIMETERS

8-Pin MSOP
NS Package Number MUA08A

MUA08A (Rev F)

Notes

Notes

For more National Semiconductor product information and proven design tools, visit the following Web sites at:

Products		Design Support	
Amplifiers	www.national.com/amplifiers	WEBENCH	www.national.com/webench
Audio	www.national.com/audio	Analog University	www.national.com/AU
Clock Conditioners	www.national.com/timing	App Notes	www.national.com/appnotes
Data Converters	www.national.com/adc	Distributors	www.national.com/contacts
Displays	www.national.com/displays	Green Compliance	www.national.com/quality/green
Ethernet	www.national.com/ethernet	Packaging	www.national.com/packaging
Interface	www.national.com/interface	Quality and Reliability	www.national.com/quality
LVDS	www.national.com/lvds	Reference Designs	www.national.com/refdesigns
Power Management	www.national.com/power	Feedback	www.national.com/feedback
Switching Regulators	www.national.com/switchers		
LDOs	www.national.com/ldo		
LED Lighting	www.national.com/led		
PowerWise	www.national.com/powerwise		
Serial Digital Interface (SDI)	www.national.com/sdi		
Temperature Sensors	www.national.com/tempsensors		
Wireless (PLL/VCO)	www.national.com/wireless		

THE CONTENTS OF THIS DOCUMENT ARE PROVIDED IN CONNECTION WITH NATIONAL SEMICONDUCTOR CORPORATION ("NATIONAL") PRODUCTS. NATIONAL MAKES NO REPRESENTATIONS OR WARRANTIES WITH RESPECT TO THE ACCURACY OR COMPLETENESS OF THE CONTENTS OF THIS PUBLICATION AND RESERVES THE RIGHT TO MAKE CHANGES TO SPECIFICATIONS AND PRODUCT DESCRIPTIONS AT ANY TIME WITHOUT NOTICE. NO LICENSE, WHETHER EXPRESS, IMPLIED, ARISING BY ESTOPPEL OR OTHERWISE, TO ANY INTELLECTUAL PROPERTY RIGHTS IS GRANTED BY THIS DOCUMENT.

TESTING AND OTHER QUALITY CONTROLS ARE USED TO THE EXTENT NATIONAL DEEMS NECESSARY TO SUPPORT NATIONAL'S PRODUCT WARRANTY. EXCEPT WHERE MANDATED BY GOVERNMENT REQUIREMENTS, TESTING OF ALL PARAMETERS OF EACH PRODUCT IS NOT NECESSARILY PERFORMED. NATIONAL ASSUMES NO LIABILITY FOR APPLICATIONS ASSISTANCE OR BUYER PRODUCT DESIGN. BUYERS ARE RESPONSIBLE FOR THEIR PRODUCTS AND APPLICATIONS USING NATIONAL COMPONENTS. PRIOR TO USING OR DISTRIBUTING ANY PRODUCTS THAT INCLUDE NATIONAL COMPONENTS, BUYERS SHOULD PROVIDE ADEQUATE DESIGN, TESTING AND OPERATING SAFEGUARDS.

EXCEPT AS PROVIDED IN NATIONAL'S TERMS AND CONDITIONS OF SALE FOR SUCH PRODUCTS, NATIONAL ASSUMES NO LIABILITY WHATSOEVER, AND NATIONAL DISCLAIMS ANY EXPRESS OR IMPLIED WARRANTY RELATING TO THE SALE AND/OR USE OF NATIONAL PRODUCTS INCLUDING LIABILITY OR WARRANTIES RELATING TO FITNESS FOR A PARTICULAR PURPOSE, MERCHANTABILITY, OR INFRINGEMENT OF ANY PATENT, COPYRIGHT OR OTHER INTELLECTUAL PROPERTY RIGHT.

LIFE SUPPORT POLICY

NATIONAL'S PRODUCTS ARE NOT AUTHORIZED FOR USE AS CRITICAL COMPONENTS IN LIFE SUPPORT DEVICES OR SYSTEMS WITHOUT THE EXPRESS PRIOR WRITTEN APPROVAL OF THE CHIEF EXECUTIVE OFFICER AND GENERAL COUNSEL OF NATIONAL SEMICONDUCTOR CORPORATION. As used herein:

Life support devices or systems are devices which (a) are intended for surgical implant into the body, or (b) support or sustain life and whose failure to perform when properly used in accordance with instructions for use provided in the labeling can be reasonably expected to result in a significant injury to the user. A critical component is any component in a life support device or system whose failure to perform can be reasonably expected to cause the failure of the life support device or system or to affect its safety or effectiveness.

National Semiconductor and the National Semiconductor logo are registered trademarks of National Semiconductor Corporation. All other brand or product names may be trademarks or registered trademarks of their respective holders.

Copyright© 2008 National Semiconductor Corporation

For the most current product information visit us at www.national.com



National Semiconductor Americas Technical Support Center
 Email: support@nsc.com
 Tel: 1-800-272-9959

National Semiconductor Europe Technical Support Center
 Email: europe.support@nsc.com
 German Tel: +49 (0) 180 5010 771
 English Tel: +44 (0) 870 850 4288

National Semiconductor Asia Pacific Technical Support Center
 Email: ap.support@nsc.com

National Semiconductor Japan Technical Support Center
 Email: jpn.feedback@nsc.com